

BROCHURE

Motors in data centers

Powering the connected world

BALDOR • RELIANCE



Sustainability for the future

Motors are the hidden workhorses that help provide the cooling and power needed by keep data centers running. By selecting the right motor, you can prolong equipment life, increase efficiency and cut electricity consumption.

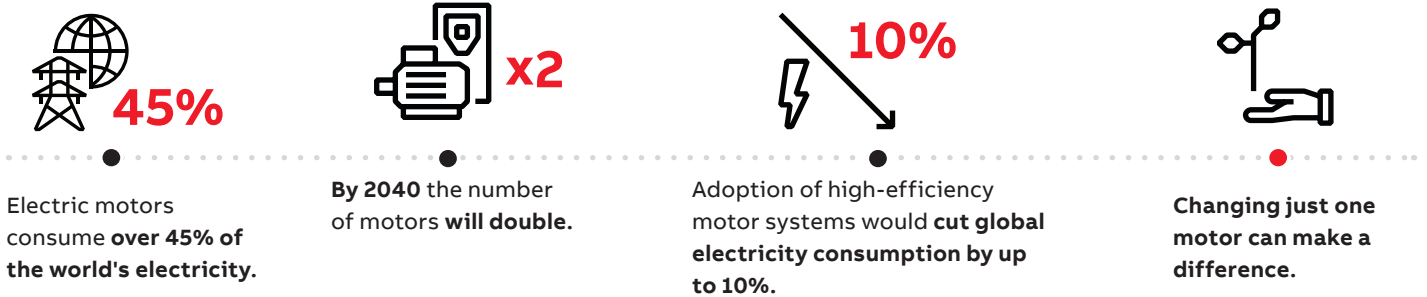

Power usage effectiveness (PUE) is a ratio defined as the power used by a data center divided by the power used by its IT equipment. Specifically, it shows how much power is used by the actual IT equipment as compared with the power used by all the data center's services, which also includes cooling, lighting, power network equipment and so on.

The power used for servers is roughly the same as the power used cooling the facility - so it makes sense to focus on both white and gray spaces within a data center to optimize PUE. By adopting best practices, it is possible to reach an average annual PUE of 1.1 and even lower.

Typical data center energy use

$$PUE^* = \frac{\text{Power}_{\text{Total}}}{\text{Power}_{\text{IT load}}}$$

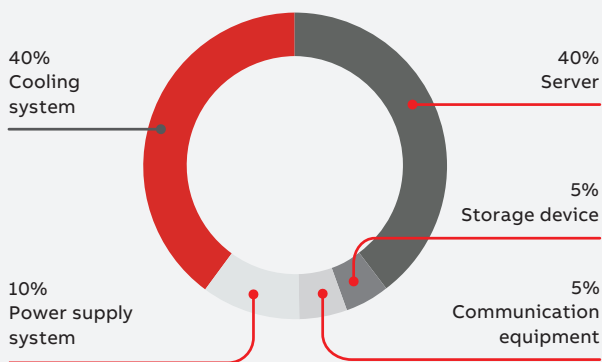

*Power Usage Effectiveness

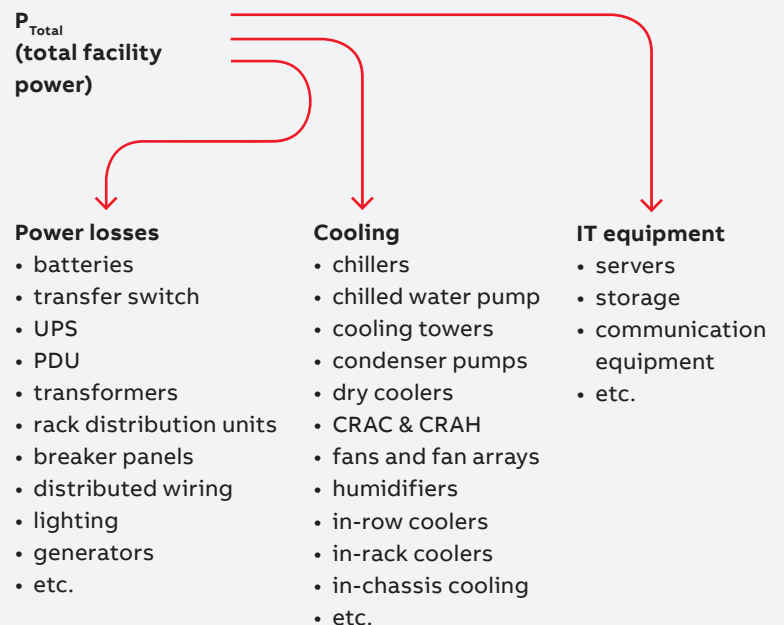

Baldor-Reliance®

Motors for data centers

Baldor-Reliance is the number one choice for NEMA industrial motors, and ABB has a large installed base in fans, pumps, and compressors found in data centers today. Selecting the right motor will increase uptime that is critical for a data center to continue running, while also reducing power consumption. In addition, we have a deep understanding around what is unique to data centers, in both white and gray space areas – and increasing the system efficiency to get your campus closer to a 1.0 PUE (Power Usage Effectiveness).



Uptime 24/7/365

Our motors are constructed like none other – with superior insulation, windings, ingress protection, even hardware. Our motors are proven to be best in class.



Inverter duty

Variable speed applications are used throughout data centers to maximize on efficiency. Pairing a drive to control a motor can save 40 - 60 percent in energy costs compared to direct on line performance.



Saving energy

We have a line of motors that perform beyond IE5 efficiency levels. Save on your energy bill and improve your PUE.

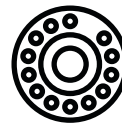

Bearing protection

Bearing protection is critical in motors that are used with VFDs. Shaft currents can become a major issue if bearings are not properly protected.

—
Critical Cooling motors
for fan arrays

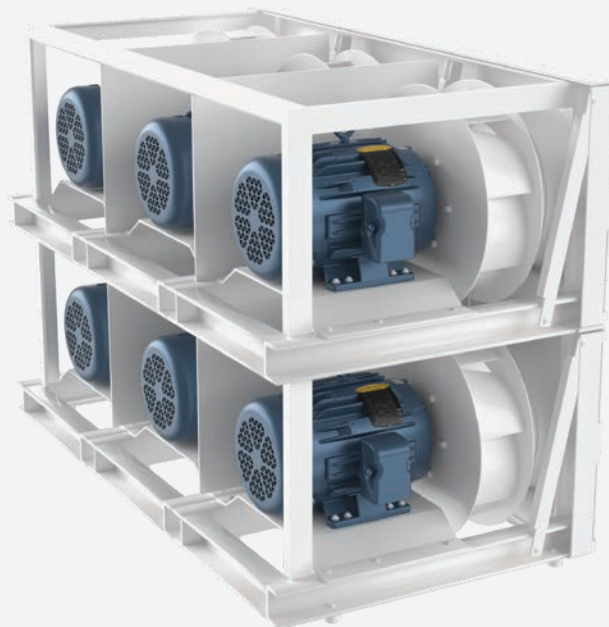

Data center cooling systems and technologies

The right choice to maximize PUE



White space: Fan array

- Multi-motor/drive arrangements
- High efficiency with reliability needed
- Moves cool air in/hot air out



Gray space: Cooling plant control

- Cooling systems such as air handling units and cooling towers
- Motors that can withstand moisture and humidity
- ABB Ability™ digital solutions for motors, generators and drives

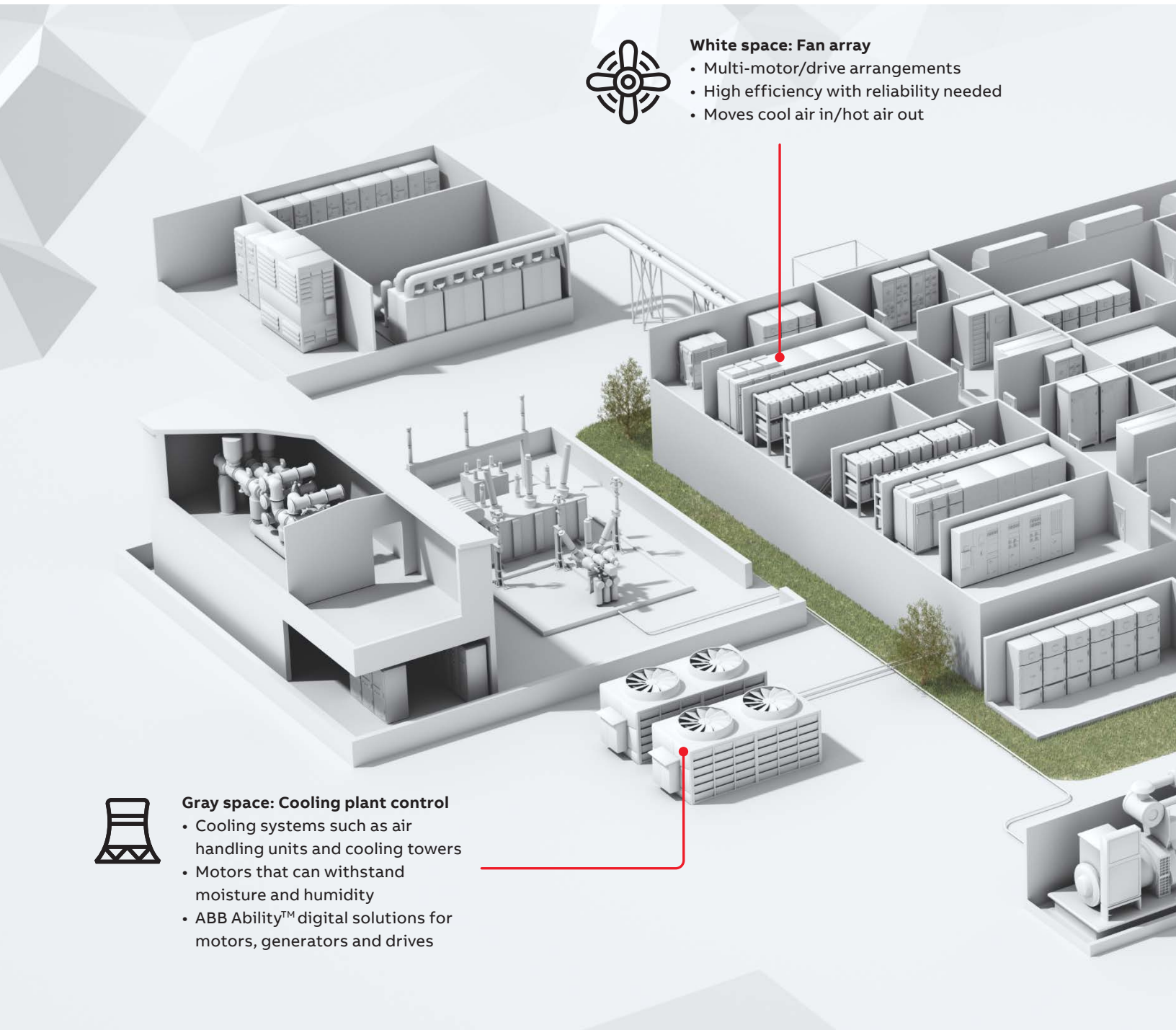

Data centers are divided into two main areas: white and gray spaces. White spaces are locations inside the data center, including server rooms, clean rooms and other areas that need precise climate control. Gray spaces are the areas outside of the server space, and these areas contain the support equipment like cooling towers and compressor rooms that help keep the inside areas of the data center cool. A typical data center could have around 500 motors in their HVAC system, making energy management very important. To make the HVAC systems more efficient, data centers often control fans, pumps and compressors with variable frequency drives (VFDs) to ensure only the energy required is being used.

Most data centers focus on the white space to improve PUE, but the way to improve white space is to ensure gray space equipment performance is operating as efficiently as possible.

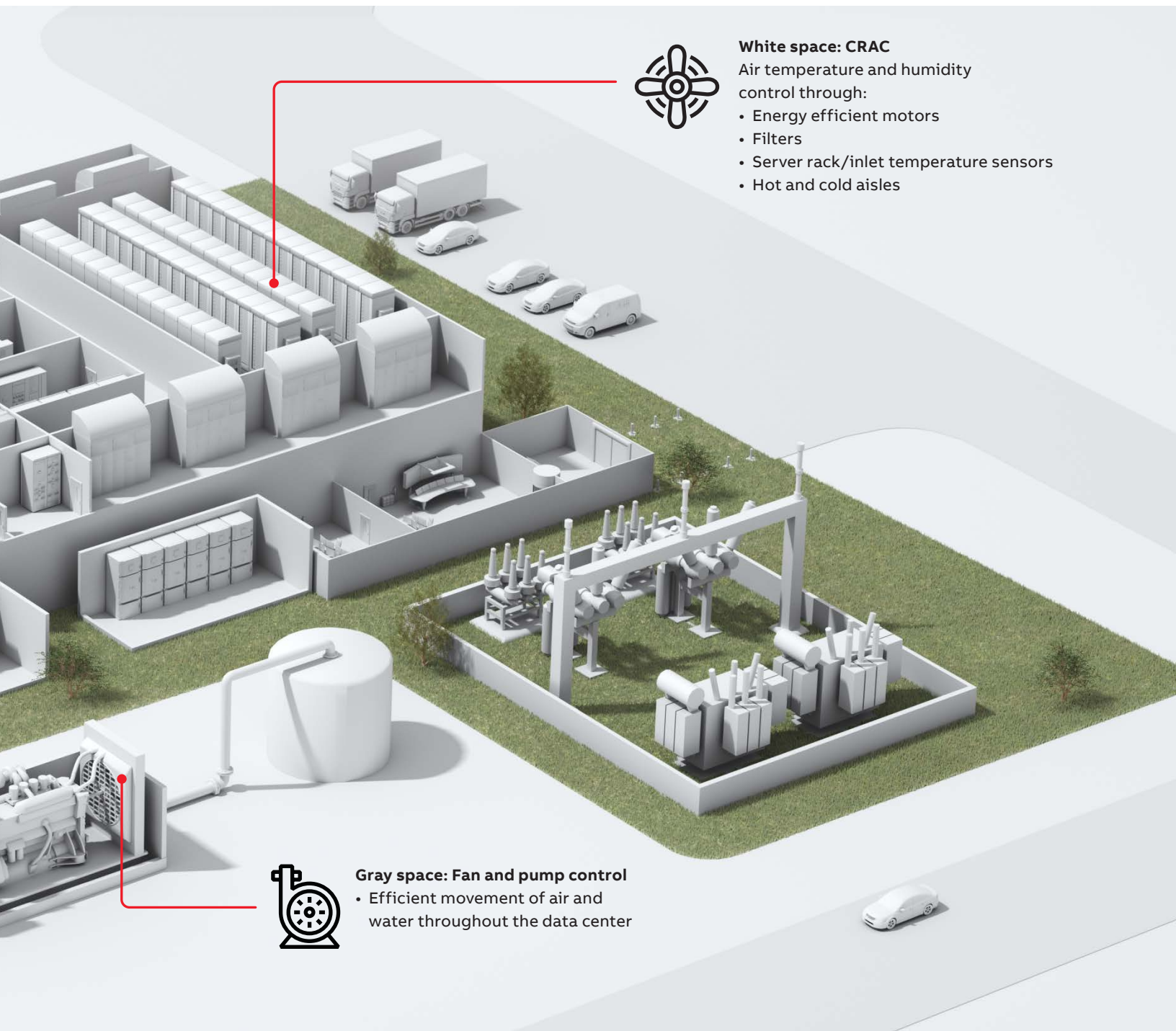
**White space: CRAC**

Air temperature and humidity control through:

- Energy efficient motors
- Filters
- Server rack/inlet temperature sensors
- Hot and cold aisles

**Gray space: Fan and pump control**

- Efficient movement of air and water throughout the data center

Critical Cooling motors

Bearing protection for mission-critical applications

Designed specifically for mission-critical applications found in data centers, hospitals, and clean rooms that cannot afford any downtime.

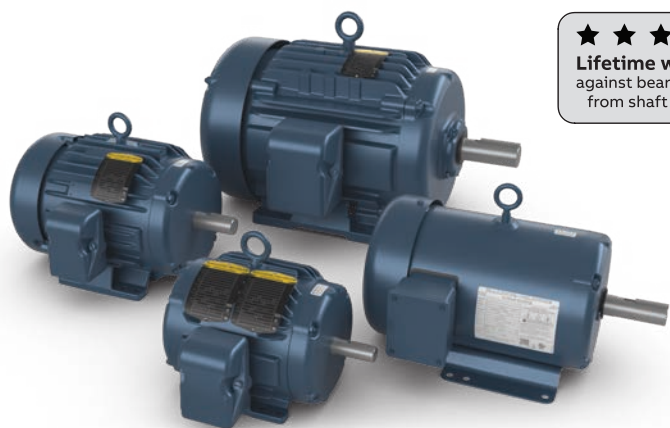

★ ★ ★ ★ ★
Lifetime warranty
 against bearing failure
 from shaft currents

- For lifetime warranty against bearing failures caused by shaft currents
- Induction rotor/NEMA Premium®/IE3 version: 1 - 30Hp (.75 - 22 kW)
- FASR rotor ultra premium efficiency/IE5+ version: 5 - 20 Hp (3.7 - 15 kW)
- Lifetime warranty against bearing failure from shaft currents
- Sealed hybrid ceramic ball bearings installed on both motor ends available from stock
- TEAO and TEFC enclosures available
- Designed for longevity with 5-year motor warranty



Sealed hybrid ceramic bearings on both motor ends



Learn when to use
 Critical Cooling motors



Induction rotor: IE3 / NEMA Premium®



FASR rotor: IE5+ / Ultra premium efficiency

EC Titanium™

Ultra-efficient IE5+ capabilities - best in the market

EC Titanium™ is a highly efficient motor that reduces power consumption for variable torque applications such as fans, pumps and compressors - improving your data center PUE and energy costs.



Integrated top-mount
(plenum use version shown)

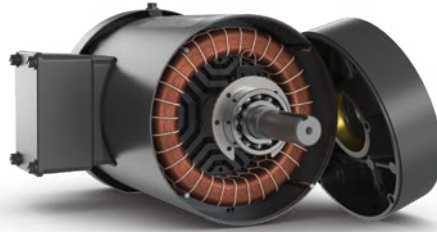

Motor only



Integrated axial-mount



- IE5+ efficiency with FASR (Ferrite Assisted Synchronous Reluctance) rotor design
- Motor only: 1 - 20 Hp (.75 - 15 kW)
- Integrated motor-drive (top mount) 1 - 10 Hp (.75 - 7.5 kW)
- Integrated motor-drive (axial mount) 1 - 7.5 Hp (.75 - 5.6 kW)
- Sustainable solution with eco-friendly components
- Internally mounted shaft grounding brush for shaft current mitigation
- Built-in ABB Ability™ and Bluetooth communication (not available with plenum use version)
- Available in: motor only, integrated motor-drive (top-mount or axial-mount) plenum-use design, C-face, footed and footless

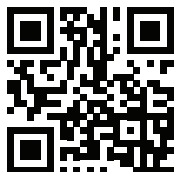

Learn about EC
Titanium used in
HVAC applications



Scan for EC Titanium
in action

Other inverter duty motors for data centers



Shaft grounded motors (-BG & -G)

Optimized for VFD use with bearing protection

- Baldor-Reliance shaft grounding brush "-BG" motors 1/2 - 50Hp (.37 - 37 kW)
- AEGIS® bearing protection ring "-G" motors 1 - 100 Hp (.75 - 75 kW)
- For inverter use per NEMA MG1 Part 31.4.4.2
- TEFC and ODP enclosures available



Shaft grounded pump motors

JM close-coupled pump optimized for VFD use

- 1 - 50 Hp (.75 - 37 kW)
- Internal AEGIS® shaft grounding brush installed
- Oversized ball bearing suitable for pump industry
- TEAO and TEFC enclosures available



General purpose motors

Single and three phase motors for the most versatile industrial use

- 1/12 - 450 Hp (.06 - 335 kW)
- Suitable for inverter use per NEMA MG1 Part 31.4.4.2
- TEFC, TENV and ODP enclosures available



Severe Duty XT motors

Robust cast-iron construction for severe duty environments

- 1 - 300 Hp (.75 - 224 kW)
- Suitable for inverter use per NEMA MG1 Part 31.4.4.2
- Division 2, Class I, Groups A, B, C, D



Chiller/cooling tower motors

For maximum protection from humidity and moisture

- 1 - 100 Hp (.75 - 75 kW)
- Internal AEGIS® shaft grounding brush installed
- 4 layer barrier system for maximum protection against ingress (Lip contact seal, V-ring slinger, double-sealed bearings, dome slinger)
- TEAO and TEFC enclosures available
- IP55



Cooling tower direct drive (CTDD)

For lower maintenance and overall system efficiency improvement

- Direct drive motor
- Laminated finned frame AC permanent magnet motor for power density
- Fan couples directly to the motor - eliminating gearbox, drive shaft, bearings and couplings
- TEAO design

Drives for data centers

Boost productivity of your process, improve energy efficiency and cut maintenance costs.

Because building systems like HVAC run at partial loads for most of the time, variable speed drives can save energy by an average of 20 to 60% compared to traditional damper or valve control methods



ACH580

Comfort control and effortless operation of your HVAC system

- Power range 1 - 670 Hp (0.75 - 500 kW)
- Voltage range 208 to 690 V
- IP21 and IP55 enclosure classes for wall-mounted drives, IP00 and IP20 for drive modules, and IP21, IP42 and IP54 for cabinet drives
- HVAC-specific features integrated as standard

ACS880

Enabling uncompromised productivity for your industrial business

- Power range .67 - 12,337 Hp (0.55 - 9,200 kW)
- Voltage range 230 to 690 V
- Enclosure classes IP00, IP20, IP21, IP42, IP54 and IP55
- Direct torque control (DTC) for precise open and closed loop control

Conventional ventilation system

System efficiency = 69% at partial loads and speeds

Input power 145



Standard Motor efficiency **91%**



Belt Drive efficiency **93%**



Fan efficiency **78%**



Damper

Output power 100

Energy-efficient ventilation system

System efficiency = 83%

Input power 121



Variable Speed Drive efficiency **98%**



Energy-efficient Motor efficiency **96%**



Better Fan efficiency **88%**

Output power 100

Shaft current mitigation techniques

Problem: Without proper wiring and grounding techniques, shaft currents induced by VFDs will find the path of least resistance, typically through the motor bearings to the ground.. This can lead to catastrophic failures to the motors.

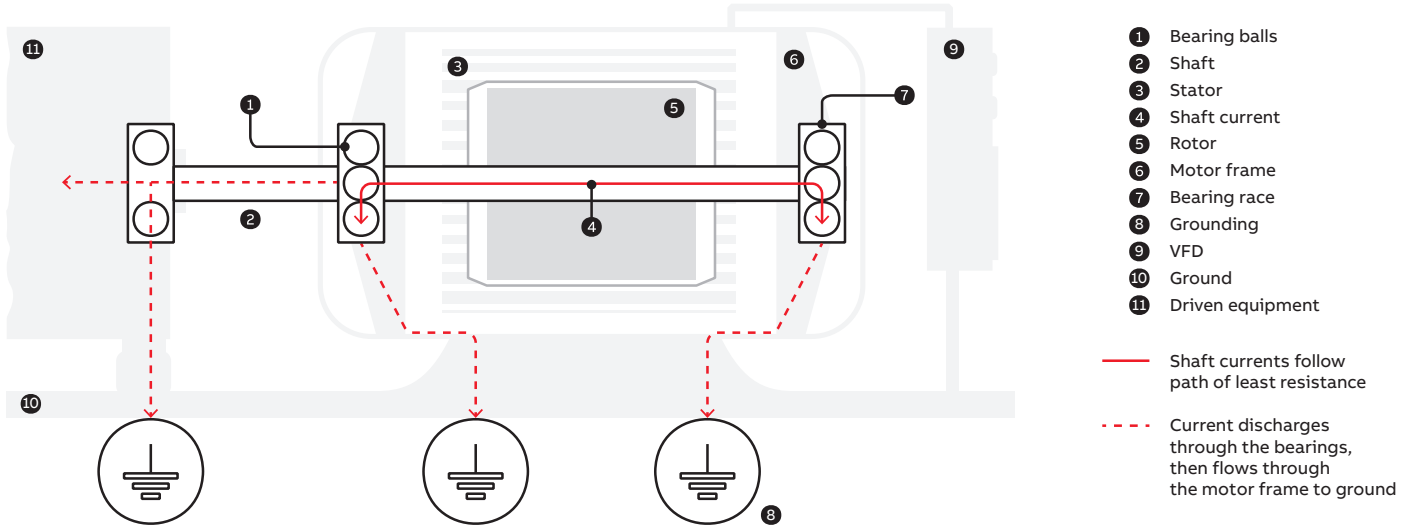

Solutions: There are many ways to mitigate shaft grounding issues, from shaft grounding rings, carbon brushes and implementing hybrid ceramic bearings.

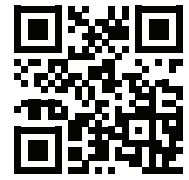

Video: Shaft currents and best practices for motor protection



Shaft-grounding rings

Pros:

- Can be mounted Internal or external
- Low maintenance - no adjustment necessary

Cons:

- If externally mounted, collects contaminants



Carbon brushes

Pros:

- Effective, tried-and-true system
- Practical, economical

Cons:

- Subject to wear
- High maintenance; needs to be adjusted periodically

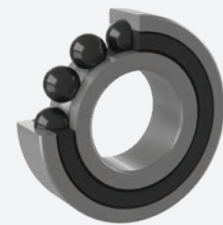

Hybrid ceramic bearings

Pros:

- Won't micro-weld
- Deflection resistant
- Corrosion resistant
- Low thermal expansion

Cons:

- Does not resolve motor current flow issues

In addition to cooling reliability, energy savings and safety, there are many other benefits to using VFDs and high-efficiency motors on motor-driven applications.

White space areas		
Challenges	Solution	Benefit
Equipment uptime	To increase motor reliability, the bearings need to be protected from shaft grounding. Utilize a shaft grounding brush or insulated bearing.	Smooth motor performance means the operation will run cooler and with less energy loss. This is also a more sustainable solution as facilities will experience longer equipment operating life.
	Condition monitoring will create an alert when there are issues with motor performance.	Predictive maintenance will prolong the performance of your equipment and prevent unplanned downtime.
High electricity consumption	Ultra premium (IE5+) efficient motors are available to greatly reduce electricity consumption over the life of the motor.	Reduce electricity consumption by 40% by adding a VFD to the motor. Using a highly-efficient motor and drive package will optimize system performance by using only the electricity needed.
	VFDs bring energy savings for pumps with half the speed meaning only 1/8 power is needed	Typically, between 20 to 60 percent energy savings compared to throttle control systems
High fan maintenance or replacement costs in case of integrated speed control solutions (i.e. EC fans)	Stand-alone VFDs	VFDs mounted separately from motors eliminate the need for a complete fan unit replacement in the case of component failure, significantly reducing the cost.
High fan installation costs	One VFD can control multiple motors in fan arrays	Reduced installation costs while ensuring required redundancy level
Gray space areas		
Challenges	Solution	Benefit
Chillers/compressors are the biggest single electricity consumers	Highly efficient motor and drive packages will help drive down electricity consumption.	It's possible to save significant electricity costs as the right compressor speed and load are achieved.
	Motor features such as humidity/weather proof seals, gaskets and bearing protection	These features increase the reliable performance of your chiller / compressor.
Cooling tower maintenance and energy costs	Gearbox failures, oil leaks, misaligned drive shafts and vibration often occur in traditional cooling tower systems which contain a motor, drive shaft and gearbox. Replace these with a direct drive option to eliminate the maintenance of a gearbox and other wear	A direct drive option reduces maintenance time and cost, but more importantly, the inefficiencies that wear items cause will be eliminated. This provides higher efficiency, lower energy costs, and lower maintenance costs.
Direct-on-line starting creates pressure shocks and damaging pumps, seals, pipe joints and valves	VFD allows for soft startup and stops to help avoid pressure peaks and water hammer	Increased lifetime of pump and piping system and decreased operating costs.
Pump uptime	Condition monitoring indicates mechanical failures like bearing wears and pipe leakage	Reduced cooling system downtime and increased reliability

All of these considerations will help a user achieve a lower PUE ratio and improve the overall uptime of the data center.

Critical data center applications

Fan arrays

Fan arrays are designed with smaller sized fans mounted to motors, either in a multi-motor configuration or 1:1 motor drive configuration. Typically, direct drive plenum fans are used in an array to create parallel airflow paths.

These fans are commonly used in data centers where space is tight and maximum airflow is required for cooling computer servers and other critical units.



CRAC

Computer Room AC units are self-contained cooling systems used in data centers.

The CRAC units have filters inside to remove dust from the rooms as well as a fan to circulate and distribute the air. Some can also humidify or dehumidify the air that's important to control static electricity in the air.

Cooling towers & chillers

Must reliably extract heat from the condenser liquid to allow a chiller to operate efficiently. Any data center that uses the outside atmosphere to introduce cooler air to the servers will also utilize cooling towers.

Chillers are used to cool the water used in the HVAC units. 24/7/365 operation of chillers are crucial to data center operation, given the considerable amount of heat produced by the servers.



Efficiency improvement and reduce maintenance costs

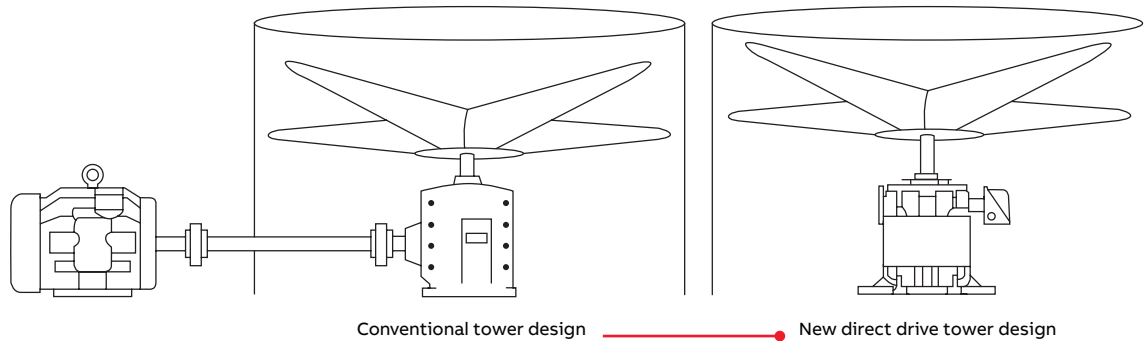

Case Study

A typical conventional fan drive arrangement of a gearbox mounted under the fan, connected to a drive shaft and motor.

RPM AC Cooling Tower Direct Drive

System design improvements:

- No gearbox
- No drive shaft or couplings
- No bearing problems
- Lower maintenance costs
- Less components – higher overall system efficiency



Local manufacturing and customer service

More than 100 years ago, we set out to build a better motor, and that's still our goal. Today, ABB is the world's number-one manufacturer of NEMA motors, and we're proud to support you locally with the Baldor-Reliance product brand. When you choose an ABB Baldor-Reliance motor, you get a product and backed by 100 years of heritage. Our motors are designed and built in Arkansas, Georgia, Mississippi and Oklahoma, and our production facilities are committed to quality and dependability so that we can provide you with a reliable motor every time.

Our team understands the challenges you face to stay productive and profitable while meeting the demands of industry and government regulations. We realize the importance of American products to many of our customers, and we can help you navigate the standards and regulations in the industries in which you operate to provide you with the right product needed.

Every year, thousands of customers make the choice to trust ABB. Your success is our success, and we work with you every step of the way to deliver a motor that exceeds your expectations. We provide a simplified approach to providing industry-specific solutions, with next-generation products, shorter lead times and the ability to outpace other motor manufacturers with faster, more efficient output and support services.

The voice of our customers drives our strategy. You are the engine that helps guide decisions in our business. We strive to keep your applications running safely, reliably and effectively - and we look for ways to continuously create value and provide a world-class customer experience. The same passion and pride you put into your business, we put into every motor we make. You don't settle for second best, and neither will we.





ABB Motors and Mechanical Inc.

5711 R.S. Boreham, Jr. Street

Fort Smith, AR 72901

Ph: 1.479.646.4711

new.abb.com/motors-generators



Scan for interactive
brochure